

TABLE OF CONTENTS

| | |
|---------------------------------------|-------|
| 1.SAFETY PRECAUTIONS | 2 |
| 2.IMPORTANT SAFETY INSTRUCTIONS | 4 |
| 3.FEATURES | 6 |
| 4.DEFINITION OF TERMS | 6 |
| 5.NAME OF PARTS | 7 |
| ° MAIN UNIT | 7 |
| ° REMOTE CONTROL | 8 |
| 6.CONNECTIONS | 9 |
| 7.PREPARATIONS BEFORE OPERATION | 11 |
| ° USE REMOTE CONTROL | 11 |
| ° PLAYABLE DISCS | 12 |
| ° USING AC ADAPTOR | 12 |
| 8.BASIC OPERATIONS | 13 |
| ° BEFORE OPERATION | 13 |
| ° LOAD DISC | 13 |
| ° TFT PICTURE ADJUSTMENT | 14 |
| ° PLAY DISC | 15 |
| ° PAUSE | 15 |
| ° OSD | 15 |
| ° DVD MENU PLAY | 19 |
| ° SELECT WITH NUMBER BUTTONS | 19 |
| 9.FUNCTION SETTING | 20 |
| ° MENU SETTING | 20-25 |
| 10.PLAY DISCS IN VARIOUS WAYS | 26 |
| ° AUDIO MODE | 26 |
| ° FAST PLAY | 27 |
| ° SLOW PLAY | 27 |
| ° REPEAT PLAY | 28 |
| ° SELECT SUBTITLES | 29 |
| ° SELECT ANGLES | 29 |
| ° TIME SEARCH | 30 |
| ° BOOKMARK | 31 |
| ° ZOOM PLAY | 31 |
| ° PROGRAM PLAY | 32 |
| ° SHUFFLE OR RANDOM PLAY | 33 |
| ° DIGEST PLAY | 33 |
| 11.MP3 OPERATION | 34 |
| 12.OTHERS | 35 |
| ° ACCESSORIES | 35 |
| ° PRECAUTIONS FOR DISC | 35 |
| ° TROUBLESHOOTING | 35 |
| ° TECHNICAL SPECIFICATIONS | 36 |
| 13.USING THE BATTERY PACK | 37 |

SAFETY PRECAUTIONS



- ∞ The lightning flash with arrowhead symbol within an equilateral triangle is intended to alert the user to the presence of uninsulated "dangerous voltage" within the product's enclosure that may be of sufficient magnitude to constitute risk of electric shock to persons.



- ∞ The exclamation point within an equilateral triangle is intended to alert the user to the presence of important operating and maintenance (servicing) instructions in the literature accompanying the product.

WARNING: To reduce the risk of fire or electric shock, do not expose this apparatus to rain or moisture. Apparatus shall not be exposed to dripping or splashing and no objects filled with liquids, such as vases, shall be placed on the apparatus.

CAUTION: To prevent electric shock, match wide blade plug to wide slot, fully insert.

CAUTION: The unit employs a laser system. To ensure the proper use of the unit, read this manual carefully and keep it for future reference. If the unit requires servicing, contact the seller or our service center-see "troubleshooting". To prevent direct exposure to the laser radiation, do not open the cabinet. Invisible laser radiation when the cabinet is opened or the interlocks are defeated. Do not stare into the laser beams. Use of any controls, adjustments, or procedures other than those specified herein may result in hazardous radiation exposure.

WARNING: Any change or modification to the unit, not expressly approved by **Memorex** or its authorized parties, could void user's authority to operate the unit.

SAFETY PRECAUTIONS

POWER SOURCES

This unit operates on a supplied AC adaptor, car adaptor and chargeable batteries.

- Make sure that the input voltage of the AC adaptor is in line with the local voltage. Otherwise, the AC adaptor and unit may be damaged.
- Do not touch the AC adaptor with wet hand so as to avoid electric shocks.
- When connecting with car power (cigarette lighter) adaptor, be sure the input voltage of the adaptor is identical with car voltage.
- Unplug the AC adaptor from the outlet or remove the chargeable batteries when the unit is not used for a long time.
- Hold the plug to disconnect the AC adaptor. Do not pull the power cord.

ON PLACEMENT

Avoid placing the unit in the following places.

- Under direct sunlight or near a source of heat such as a heater.
Never leave the unit in a closed automobile, on a dashboard or a parcel shelf. Excess heat may deform the cabin or cause malfunction.
- Where it is very dusty or sandy.
- Wet or humid places, such as bathroom.
- Near sources of strong magnetism, such as television, speaker, or magnet.
- Where there is a lot of movement or vibration, such as on a car dashboard or an unstable shelf.
- Where it is extremely hot or cold.
- Where the unit is exposed to rain or water.

FOR SAFETY

- Do not disassemble the unit for laser rays are dangerous to eyes.
Any service should be done by qualified service personnel.

- Unplug the AC adaptor to cut the power if liquid or objects get inside the unit.
- Take care not to drop the unit or subject it to strong shocks, which may cause malfunction.

Note: When unit is in use for a long period of time, the surface of the unit will be heated. This should not effect the unit ability to playback.

MAINTENANCE FOR PICKUP

- If the unit is suddenly moved from a cold place to a warm one to experience a rapid temperature change, or the unit is put in a humid place, moisture will condense on the pickup lens and result in malfunction or playback difficulties. In this case, unload the disc and leave the unit on for about one hour to evaporate the moisture.
- Keep dust from the pickup lens. Keep the disc tray closed after use. If there is dust on the pickup lens, use a cleaning disc to clean them. Please refer to the operation instructions of the cleaning disc you bought.

WHEN USING HEADPHONES

- To avoid hearing damage caused by sudden loud volume, keep the volume at the lowest level before starting play back. Then adjust it to the desired volume level.
- Keep the volume lower to protect your ears.
- Never wear headphones when driving or riding a bicycle so as to avoid traffic accidents.

IMPORTANT SAFETY INSTRUCTIONS

- (1) Read instructions - All the safety and operating instructions should be read before the product is operated.
- (2) Retain instructions - The safety and operating instructions should be retained for future reference.
- (3) Warnings - All warnings on the product and in the operating instructions should be adhered to.
- (4) Follow instructions - All operating and use instructions should be followed.
- (5) Cleaning - Unplug this product from the wall outlet before cleaning. Do not use liquid cleaners or aerosol cleaners. Use a damp cloth for cleaning.
- (6) Attachments - Do not use attachments not recommended by the product manufacturer as they may cause hazards.
- (7) Water and moisture - Do not use this product near water - for example, near a bath tub, wash bowl, kitchen sink, or laundry tub; in a wet basement; or near a swimming pool; and the like.
- (8) Accessories - Do not place this product on an unstable cart, stand, tripod, bracket, or table. The product may fall, causing serious injury to a child or adult, and serious damage to the product. Use only with a cart, stand, tripod, bracket, or table recommended by the manufacturer, or sold with the product. Any mounting of the product should follow the manufacturer's instructions, and should use a mounting accessory recommended by the manufacturer.
- (9) A product and cart combination should be moved with care. Quick stops, excessive force and uneven surfaces may cause the product and cart combination to overturn.
- (10) Power Sources - This product should be operated only from the type of power source indicated on the rear panel. If you are not sure of the type of power supplied to your home, consult your product dealer or local power company. For products intended to operate from battery power, or other sources, refer to the operating instructions.
- (11) Grounding or Polarization - This product may be equipped with a polarized alternating - current line plug (a plug having one blade wider than the other). This plug will fit into the power outlet only one way. This is a safety feature. If you are unable to insert the plug fully into the outlet, try reversing the plug. If the plug should still fail to fit, contact your electrician to replace your obsolete outlet. Do not defeat the safety purpose of the polarized plug.
- (12) Power - Cord Protection - Power - supply cords should be routed so that they are not likely to be walked on or pinched by items placed upon or against them, paying particular attention to cords at plugs, convenience receptacles, and the point where they exit from the product.
- (13) Lightning - For added protection for this product during a lightning storm, or when it is left unattended and unused for long periods of time, unplug it from the wall outlet and disconnect the antenna or cable system. This will prevent damage to the product due to lightning and power - line surges.

IMPORTANT SAFETY INSTRUCTIONS

- (14) Power Lines - An outside antenna system should not be located in the vicinity of overhead power lines or other electric light or power circuits, or where it can fall into such power lines or circuits. When installing an outside antenna system, extreme care should be taken to keep from touching such power lines or circuits as contact with them might be fatal.
- (15) Overloading - Do not overload wall outlets, extension cords, or integral convenience receptacles as this can result in a risk of fire or electric shock.
- (16) Object and Liquid Entry - Never push objects of any kind into this product through result in a fire or electric shock. Never spill liquid of any kind on the product.
- (17) Servicing - Do not attempt to service this product yourself as it must be opened by qualified service personnel.
- (18) Damages Requiring Service - Unplug this product from the wall outlet and refer servicing to qualified service personnel under the following conditions.
- When the power - supply cord or plug is damaged.
 - If liquid has been spilled, or objects have fallen into the product.
 - If the product has been exposed to rain or water.
 - If the product does not operate normally by following the operating instructions.
- Adjust only those controls that are covered by the operating instructions as an improper adjustment of other controls may result in damage and will often require extensive work by a qualified technician to restore the product to its normal operation.
- If the product has been dropped or damaged in any way.
 - When the product exhibits a distinct change in performance - this indicates a need for service.
- (19) Replacement parts - When replacement parts are required, be sure the service technician has used replacement parts specified by the manufacturer or have the same characteristics as the original part. Unauthorized substitutions may result in fire, electric shock or other hazards.
- (20) Safety Check - Upon completion of any service or repair to this product, ask the service technician to perform safety checks to determine that the product is in proper operating condition.
- (21) Heat - The product should be situated away from heat sources such as radiators, heat registers, stoves or other products (including amplifiers) that produce heat.
- (22) During playback, few bright or dark flecks may appear on the TFT LCD, which is a normal phenomenon in active matrix display technology, but not a malfunction.

FEATURES

1. HIGH DEFINITION

The unit adopts MPEG2 coding format and brings the horizontal resolution over 500 lines.

2. UNIQUE FUNCTIONS

Multi - angle and multi - language.

Parental lock makes it easy to control the content of discs.

3. ZOOM

It can enlarge pictures twice or three or four times the original size.

It can also shrink pictures 1/2, 1/3 or 1/4 as big.

4. MULTI - FUNCTIONS

Fast forward, fast reverse, slow play, frame play, repeat play and program play.

5. TIME SEARCH

It can search a specific part on a disc.

6.CONTENT DISPLAY

8" TFT LCD and English OSD, makes the disc content clearer.

7.AUDIO OUTPUT

Analog audio output, optical digital audio output can be connected with any amplifier to enjoy high quality sound effects.

8.TFT color LCD, chargeable batteries, headphone output, convenient for enjoying great pictures and beautiful music on the way.

DEFINITION OF TERMS

◦ TITLE

The images or music of a DVD are divided into units, among which title is the biggest one. Titles are broken down into chapters.

◦ CHAPTER

It is smaller than title among the units of a DVD. A title is made up of several chapters, and each chapter has a number for search.

◦ TRACK

The music in a CD. Each track has a number for search.

STRUCTURE OF DVD

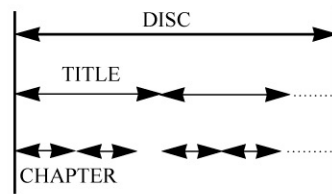

STRUCTURE OF CD

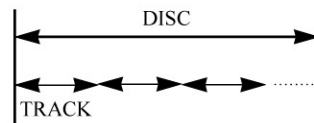

NAME OF PARTS

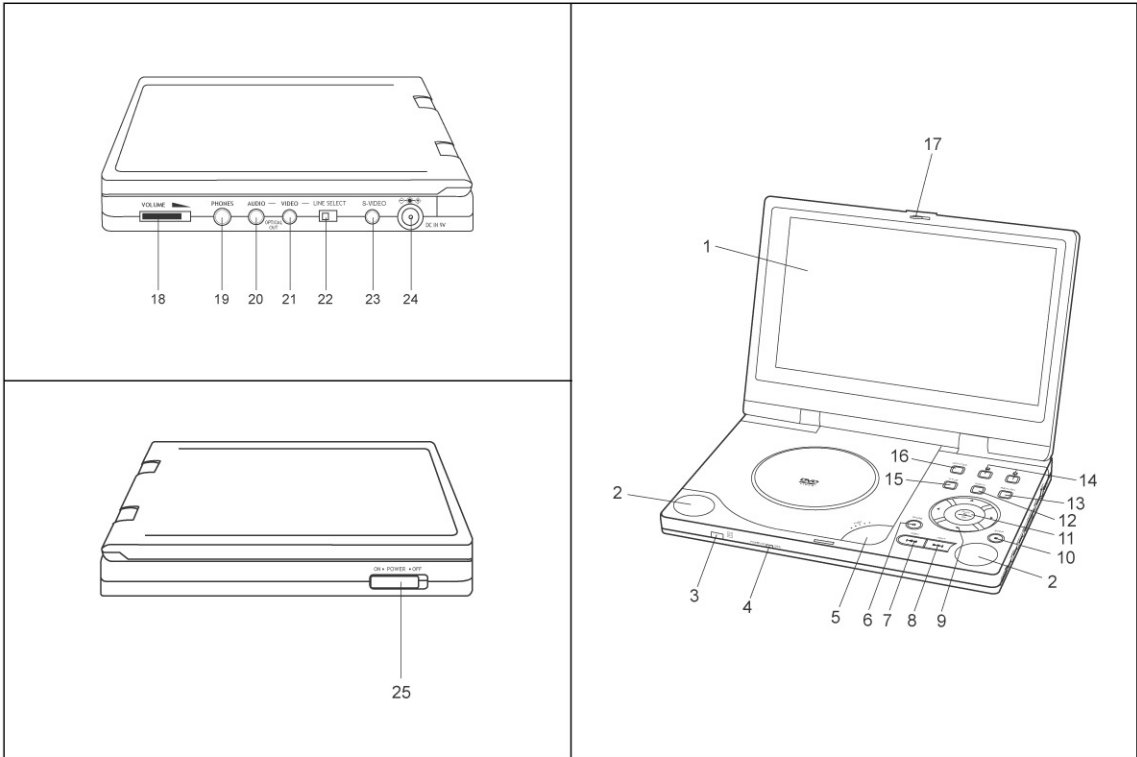

MAIN UNIT

- | | |
|----------------------------|------------------------------|
| (1) TFT LCD | (14) +/- BUTTONS |
| (2) SPEAKER | (15) TITLE |
| (3) REMOTE SENSOR | (16) MONITOR |
| (4) POWER ON/CHG INDICATOR | (17) LOCK |
| (5) PUSH OPEN | (18) VOLUME ADJUSTMENT WHEEL |
| (6) PAUSE | (19) PHONES JACK |
| (7) PREVIOUS | (20) AUDIO OUT/OPTICAL OUT |
| (8) NEXT | (21) VIDEO OUT |
| (9) DIRECTION BUTTONS | (22) LINE SELECT |
| (10) STOP | (23) S-VIDEO OUT |
| (11) PLAY/OK | (24) DC IN |
| (12) MENU | (25) POWER ON/OFF |
| (13) RETURN | |

NAME OF PARTS

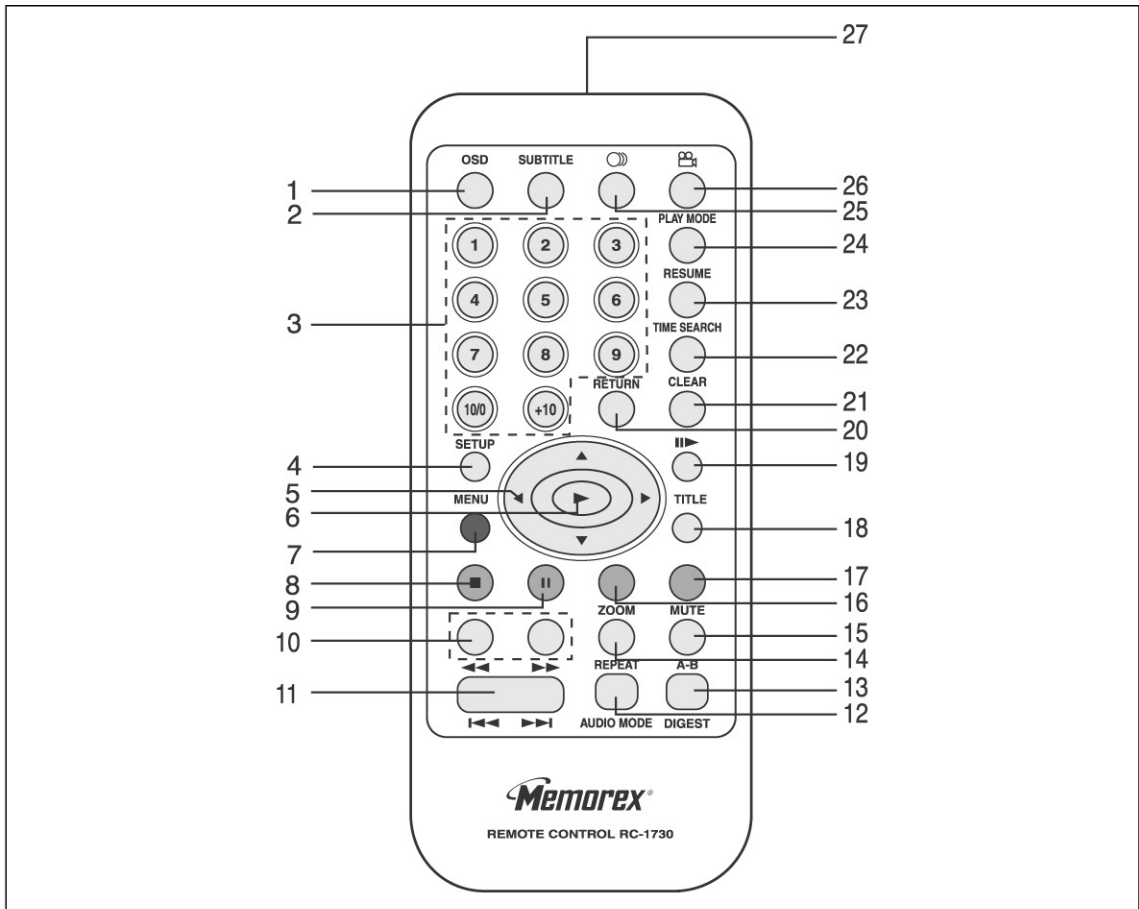

° REMOTE CONTROL

- | | |
|-----------------------|-------------------------|
| (1) OSD | (15) A-B REPEAT |
| (2) SUBTITLE | (16) ZOOM |
| (3) NUMBER BUTTONS | (17) MUTE |
| (4) SETUP | (18) TITLE |
| (5) DIRECTION BUTTONS | (19) SLOW PLAY |
| (6) PLAY | (20) RETURN |
| (7) MENU | (21) CLEAR |
| (8) STOP | (22) TIME SEARCH |
| (9) PAUSE | (23) RESUME |
| (10) FF/FR SEARCH | (24) PLAY MODE |
| (11) PREV/NEXT SKIP | (25) LANGUAGE |
| (12) AUDIO MODE | (26) ANGLE |
| (13) DIGEST | (27) REMOTE TRANSMITTER |
| (14) REPEAT | |

CONNECTIONS

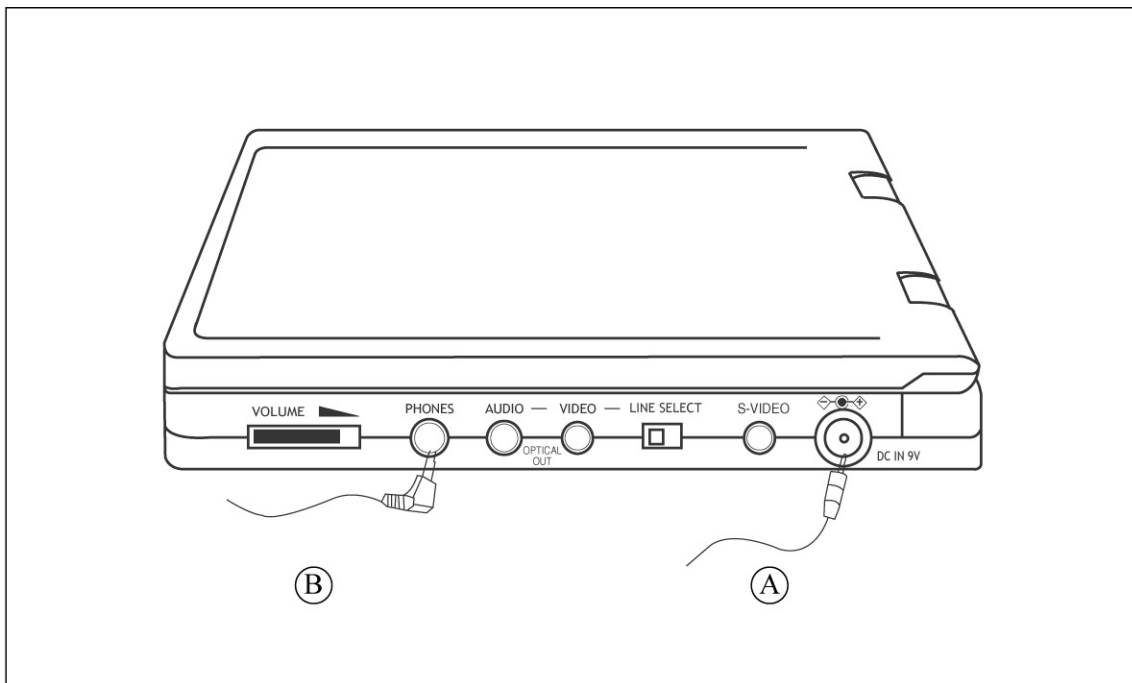

CONNECT TO POWER → (A)

Please make sure that the supplied AC adaptor is in line with the local voltage. Connect the supplied AC adaptor to:

1. DC IN on the left side of the unit.
2. The AC power outlet

USE HEADPHONES → (B)

- ☞ Insert headphones into the headphone jack of the unit.

CONNECTING TO OTHER EQUIPMENT

You can connect the unit to a TV or an amplifier to enjoy DVDs, CDs or MP3s in your home.

BEFORE CONNECTING

- ☞ Turn off the power of the unit and other equipment.
- ☞ Insert the plug fully.
- ☞ Hold the plug to disconnect the cord, do not pull the cord.

CONNECTIONS

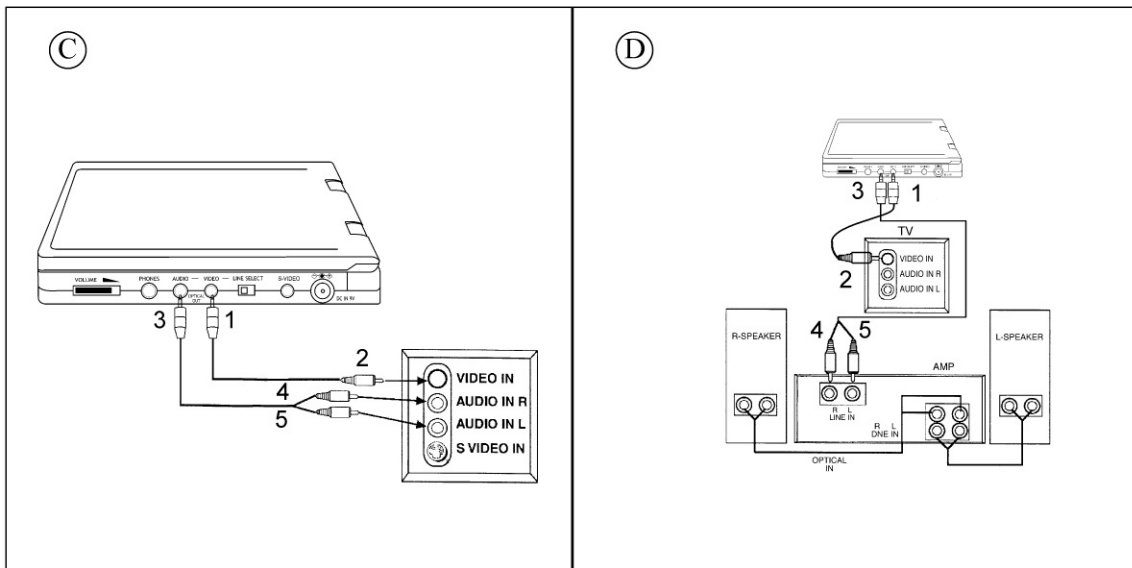

CONNECT TO TV → (C)

The AV cords are connected according to diagram (C) :

1. Mini - plug: connect to the VIDEO OUT jack of the unit.
2. Yellow plug: connect to the VIDEO IN jack of the TV.
3. Mini - plug: connect to the AUDIO OUT jack of the unit.
4. Red - plug: connect to the AUDIO IN R jack of the TV.
5. White - plug: connect to the AUDIO IN L jack of the TV.

CONNECT TO TV AND AMPLIFIER → (D)

The AV cords are connected according to diagram (D) :

1. Mini - plug: connect to the VIDEO OUT jack of the unit.
2. Yellow plug: connect to the VIDEO IN jack of the TV.
3. Mini - plug: connect to the AUDIO OUT jack of the unit.
4. Red - plug: connect to the LINE IN R jack of the amplifier.
5. White - plug: connect to the LINE IN L jack of the amplifier.

PREPARATIONS BEFORE OPERATION

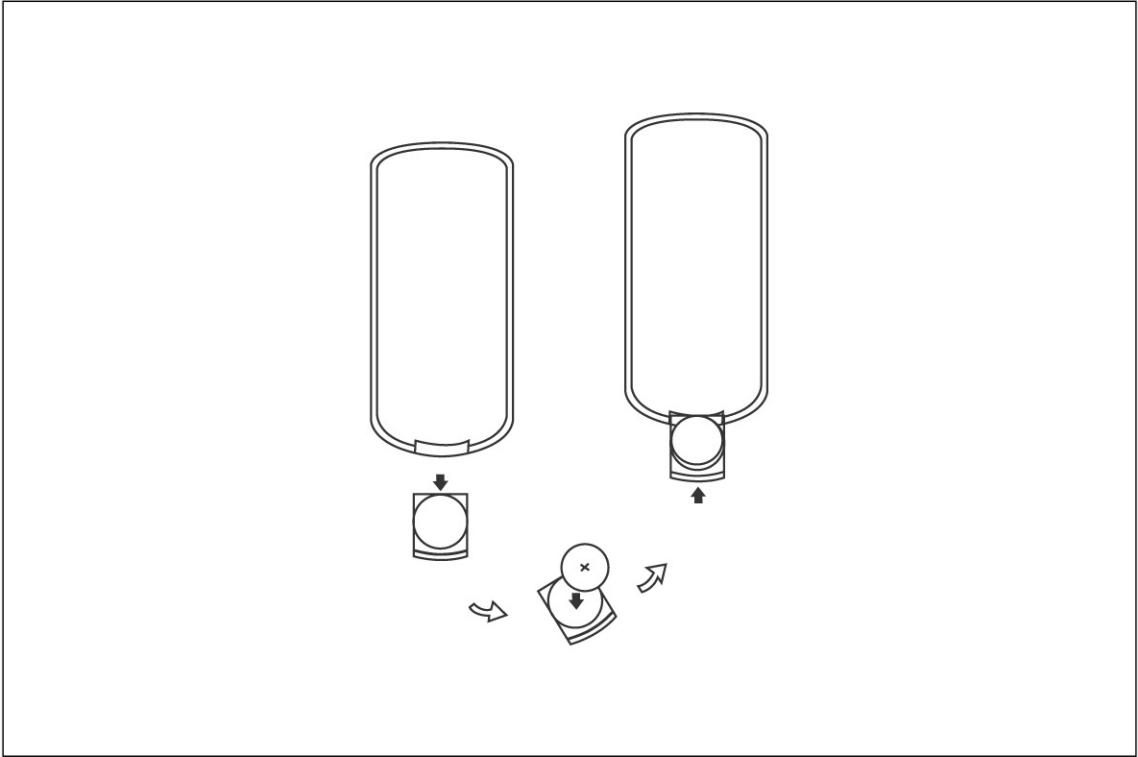



USE REMOTE CONTROL



- 1.Refer to the diagram, open the battery compartment of the remote control, insert batteries, then close the compartment.
- 2.To use the remote control, point it at the remote sensor of the unit, operate in the range of 5 meters and 60°.
- 3.Generally, batteries last for about one year, replace the batteries if the remote control does not work.
- 4.Remove the batteries if remote control is not used for a long time.

PREPARATIONS BEFORE OPERATION

PLAYABLE DISCS

| TYPE | DISC LOGO | CONTENT | SIZE | PLAYING TIME |
|------|---|----------------------------------|------|---------------------------------|
| DVD |  | audio+video (motion pictures) | 12cm | about 2hrs(single-side disc) |
| | | | | about 4hrs (double-side disc) |
| | | | 8cm | about 80mins(single-side disc) |
| | | | | about 160mins(double-side disc) |
| CD |  | audio | 12cm | about 74mins |
| | | | 8cm | about 20mins |
| MP3 | | audio | 12cm | about 600mins |

◦ The marks shown in the following chart are used in the manual.

| MARK | INDICATION |
|---|------------------|
|  | functions of DVD |
|  | functions of CD |

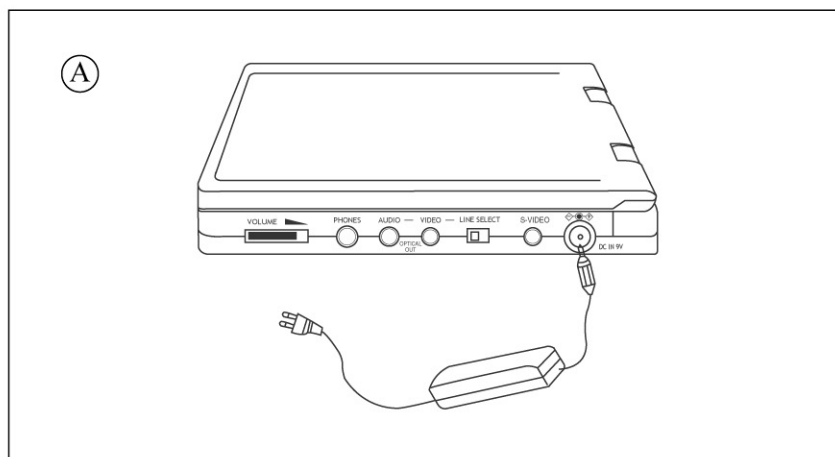

USING AC ADAPTOR → (A)

The unit can use special applied AC adaptor.

- 1.Insert the AC adaptor into DC IN jack of the unit.
- 2.Insert one end of the power supply cord into the input jack of the adaptor and the other end into the household mains socket.

Note: Turn off the unit before unplugging the AC adaptor from the unit so as to avoid the unit being damaged.

BASIC OPERATIONS

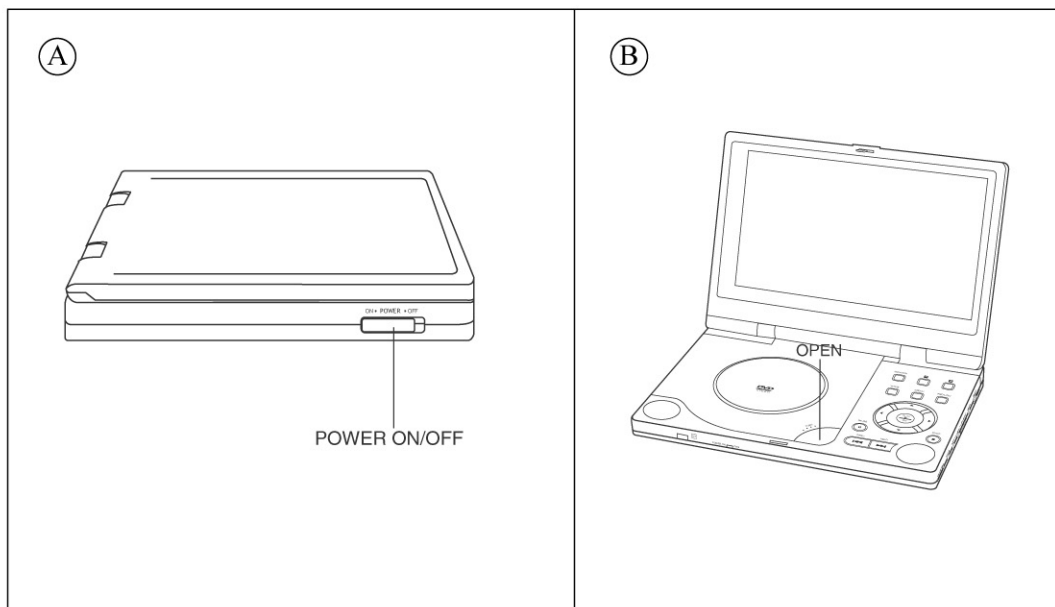

BEFORE OPERATION → (A)

1. Turn on the power.
2. Press the lock switch to open the cabinet cover.
3. Set POWER ON.
4. Turn VOLUME to adjust volume. (including when using headphones).
5. When the unit is connected to a TV or an amplifier, adjust the volume according to owner's manual and set TV to AV mode.

LOAD DISC → (B)

1. Press OPEN to open the disc door.
2. Hold the edge of the disc to put it in the center with the printed side up.
3. Close the disc door, wait until it clicks.

BASIC OPERATIONS

TFT PICTURE ADJUSTMENT

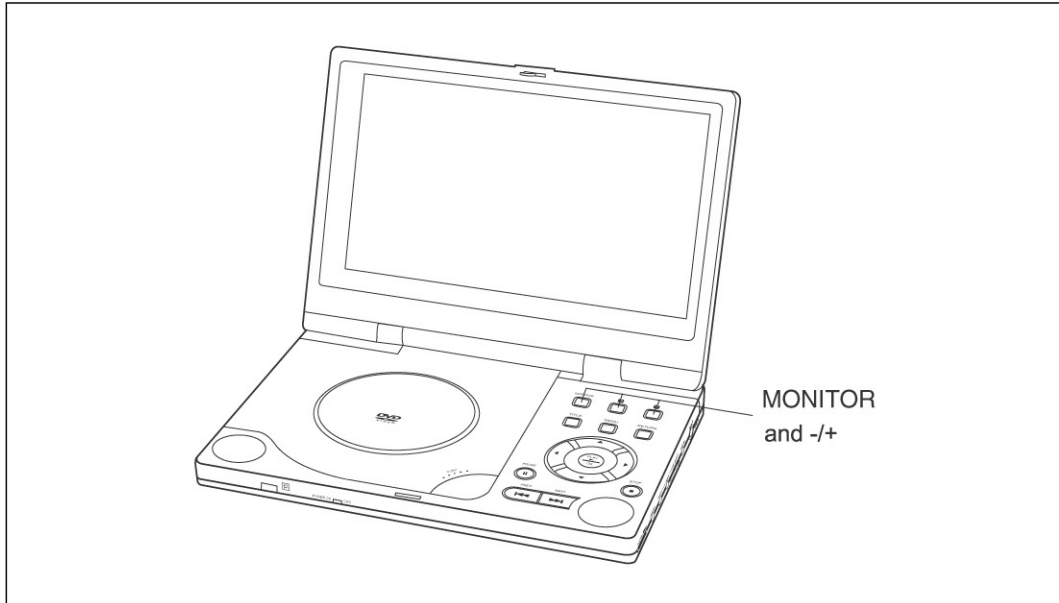

1. If you feel bright unsuitable during playback, press MONITOR button to select bright adjustment and press + or - buttons until moderate bright is available.
2. If you feel color unsuitable during playback, press MONITOR button to select color adjustment and press + or - buttons until moderate color is available.
3. Press MONITOR button to select display mode selection and press + or - buttons buttons to select: Full mode and Normal mode.

Note: During playback, few bright or dark flecks may appear on the TFT LCD, which is a normal phenomenon in active matrix display technology, but not a malfunction.

BASIC OPERATIONS

PLAY DISCS



1. Load a disc and press ► (PLAY) to play the disc.
2. Stop playback.
Press °^ (STOP).
3. Remove the disc and switch off the unit.
 - You have to press this " °^ " button twice to stop the playback of DVD discs.

PAUSE



Press 

◦ WHEN PLAYING PICTURES

If the pictures of DVD are played, press  to make playback pause.

The unit enters step play status. Each time you press , the picture advances one frame.





◦ WHEN PLAYING MUSIC CD

Press  to make playback pause.

Press ► (PLAY) to resume playback.

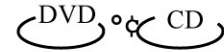
OSD



The On-Screen Display (OSD) contains many playback features. To see the Display, press the  button on the remote while a disc is playing. The picture being played will be zoomed out to the top of the screen. The Display appears under the zoomed picture. Use the ▲ or ▼ buttons on the remote to move through the different playback features in the Display.

When a playback feature is highlighted, press the ► (PLAY) button and the text box by the right side of it will be highlight. Use the ▲ or ▼ buttons on the remote to move through the choices displayed in the text box.

Remember, you can only access the Display when you're playing a disc. Also, the Display features are only available if the disc was created with that particular feature.

The invalid symbol "⊗" appears on the screen when you press a button that doesn't have any function. If one of the playback features is "grayed out", that Display feature isn't available for the disc you're playing.

To make the Display disappear from the screen, press  on the remote.

WHEN PLAYING DVD

DVD discs have the following playback features: Title, Chapter, Audio, Subtitle, Angle, TT (Title) Time, CH (Chapter) Time, Repeat and Time Display.

BASIC OPERATIONS

◦^ Selecting a Title

Some discs contain more than one title. Each title is divided into chapters. To select a title:

1. While the disc is playing, press **OSD** on the remote to bring up the Display.
2. If "Title" on the Display isn't highlighted, use the ▲ or ▼ buttons to highlight it.
3. Press the ► (PLAY) button, the text box by the right side is now highlighted.
4. Use the number buttons on the remote to enter a title number that you want to play.

Note: Some discs only have one title.

◦^ Selecting a Chapter

Because DVD discs use digital technology, a title can be divided into chapters (similar to tracks on a CD). You can skip to a specific chapter by using the Chapter feature in the Display.

1. While the disc is playing, press **OSD** on the remote to bring up the Display.
2. Press the ▲ or ▼ buttons to highlight "Chapter".
3. Press the ► (PLAY) button, the text box by the right side is now highlighted.
4. Use the number buttons on the remote to enter a chapter number that you want to play.

Notes: The Chapter feature won't work if the disc isn't formatted with separate chapters. You can also advance to the next chapter by pressing ►| on the remote and go to the preceding chapter by pressing |◀ on the remote.

◦^ Changing the Audio Language

If the disc was created with different language tracks (recorded in different languages), you can use the Display to temporarily change the DVD player's Audio Language setting.

1. While the disc is playing, press **OSD** on the remote to bring up the Display.
2. Press the ▲ or ▼ buttons to highlight "Audio".
3. Press the ► (PLAY) button, the audio languages appear on the screen.
4. Press the ▲ or ▼ buttons to move through the audio languages that are available on the disc. Press the ► (PLAY) button when the audio language you want to use is highlighted.
5. To make the Display disappear, press the **OSD** button on the remote.

Note: The Language feature only works if the disc was created with multiple audio tracks. When you choose an audio language from the Display, you only override the audio language setting in the DVD player's main menu temporarily.

The audio language can also be changed through the DVD player menu.

◦^ Changing the Subtitle Language

If the disc was created with different subtitles, you can use the Display to change the Subtitle language.

1. While the disc is playing, press **OSD** on the remote to bring up the Display.
2. Press the ▲ or ▼ buttons to highlight "Subtitle".
3. Press the ► (PLAY) button, the subtitle languages appears.

BASIC OPERATIONS

4. Press the ▲ or ▼ buttons to move through the subtitle languages that are available on the disc. Press the ► (PLAY) button when the subtitle language you want to use is highlighted.
5. To make the Display disappear, press the **OSD** button on the remote.

Note: Changing the subtitle language with the Display will only affect the disc currently being played. When the disc is removed or the player is turned off, the subtitle language will revert to the language setting specified through the DVD player main menu.

The subtitle language can also be changed through the DVD player menu.

◦^ **Changing the Camera Angle**

Some discs contain multiple angles of a particular scene or sequence. When multiple angles are available, to change the camera angle:

1. While the disc is playing, press **OSD** on the remote to bring up the Display.
2. Press the ▲ or ▼ buttons to highlight "Angle".
3. Press the ► (PLAY) button, the text box by the right side is now highlighted.
4. Use the number buttons to enter an angle number that you want to play.
5. To make the Display disappear, press the **OSD** button on the remote.

◦^ **Setting Title Time**

You can skip to a specific title time by using the Title Time feature in the Display.

1. While the disc is playing, press **OSD** on the remote to bring up the Display.
2. Press the ▲ or ▼ buttons to highlight "TT (Title) Time".
3. Press the ► (PLAY) button, the text box by the right side is now highlighted.
4. Use the number buttons on the remote to enter a title time that you want to play.

◦^ **Setting Chapter Time**

You can skip to a specific chapter time by using the Chapter Time feature in the Display.

1. While the disc is playing, press **OSD** on the remote to bring up the Display.
2. Press the ▲ or ▼ buttons to highlight "CH (Chapter) Time".
3. Press the ► (PLAY) button, the text box by the right side is now highlighted.
4. Use the number buttons on the remote to enter a chapter time that you want to play.

◦^ **Using the Repeat Feature**

The default mode for the Repeat feature is OFF. There are three Repeat options:

- All-repeats the disc that is playing
- Title-repeats the title that is playing
- Chapter-repeats the chapter that is playing

To Use Repeat:

1. While the disc is playing, press **OSD** on the remote to bring up the Display.
2. Press the ▲ or ▼ buttons to highlight "Repeat".
3. Press the ► (PLAY) button, the repeat options appears.
4. Press the ▲ or ▼ buttons to move through the repeat options. Press the ► (PLAY) button when the repeat option you want to use is highlighted.
5. The selected repeat option will loop repeatedly until you turn Repeat off.

BASIC OPERATIONS

How to Cancel Repeat:

- Press STOP twice.
- Go to Repeat feature in the Display and select Off.
- Eject the disc.

◦^ **Shifting the Displayed Time**

Using the Time Display feature in the Display, you can shift the time displayed on the screen, between: Title Elapsed Time, Title Remain Time, Chapter Elapsed Time, and Chapter Remain Time.

1. While the disc is playing, press **OSD** on the remote to bring up the Display.
2. Press the ▲ or ▼ buttons to highlight "Time Disp".
3. Press the ► (PLAY) button, the time options appears.
4. Press the ▲ or ▼ buttons to move through the time options. Press the ► (PLAY) button when the option you want to use is highlighted.
5. To make the Display disappear, press the **OSD** button on the remote.

WHEN PLAYING CD

CD discs have the following playback features: Track, Disc Time, Track Time, Repeat and Time Display.

◦^ **Selecting a specific Track**

1. While the disc is playing, press **OSD** on the remote to bring up the Display.
2. Press the ▲ or ▼ buttons to highlight "Track".
3. Press the ► (PLAY) button, the text box by the right side is now highlighted.
4. Use the number buttons on the remote to enter a track number that you want to play.

◦^ **Setting Disc Time**

You can skip to a specific disc time by using the Disc Time feature in the Display.

1. While the disc is playing, press **OSD** on the remote to bring up the Display.
2. Press the ▲ or ▼ buttons to highlight "Disc Time".
3. Press the ► (PLAY) button, the text box by the right side is now highlighted.
4. Use the number buttons on the remote to enter a disc time that you want to play.

◦^ **Setting Track Time**

You can skip to a specific track time by using the Track Time feature in the Display.

1. While the disc is playing, press **OSD** on the remote to bring up the Display.
2. Press the ▲ or ▼ buttons to highlight "Track Time".
3. Press the ► (PLAY) button, the text box by the right side is now highlighted.
4. Use the number buttons on the remote to enter a track time that you want to play.

◦^ **Using the Repeat Feature**

The default mode for the Repeat feature is OFF.

There are two Repeat options for CDs:

- All-repeats the disc that is playing
- Track-repeats the track that is playing

To Use Repeat:

1. While the disc is playing, press **OSD** on the remote to bring up the Display.
2. Press the ▲ or ▼ buttons to highlight "Repeat".
3. Press the ► (PLAY) button, the repeat options appears.
4. Press the ▲ or ▼ buttons to move through the repeat options. Press the ► (PLAY) button when the repeat option you want to use is highlighted.
5. The selected repeat option will loop repeatedly until you turn Repeat off.

BASIC OPERATIONS

◦^ Shifting the Displayed Time

Using the Time Display feature in the Display, you can shift the time displayed on the screen, between: Single (Track) Elapsed Time, Single (Track) Remain Time, Total (Disc) Elapsed Time, and Total (Disc) Remain Time.

1. While the disc is playing, press **[OSD]** on the remote to bring up the Display.
2. Press the **▲** or **▼** buttons to highlight "Time Disp".
3. Press the **▶** (PLAY) button, the time options appears
4. Press the **▲** or **▼** buttons to move through the time options. Press the **▶** (PLAY) button when the option you want to use is highlighted.
5. To make the Display disappear, press the **[OSD]** button on the remote.

You can also do as follows:

1. Press **▼** to select track 13.

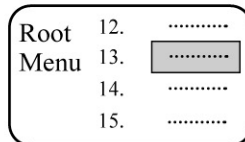

2. Press **▶** (PLAY) to start playing track 13.

Press **[TITLE]** once to return to the title menu.
Press **[MENU]** once to return to the root menu.

SELECT WITH NUMBER BUTTONS (CD)

Load a disc. Press number buttons to select tracks after the unit finishes reading the disc.

1. If the track number isn't over 10, just push buttons 1-10.
Example: push **[8]** to select track 8.

The screen shows:

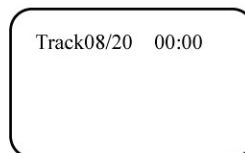

2. If the track number is over 10, press **[+10]** once and a button among 1-10.
Example: if you select track 12, press **[+10]** once and button **[2]**.

The screen shows:

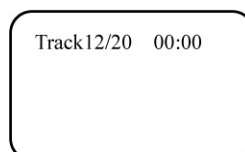

DVD MENU PLAY (DVD)

some DVDs have title menus and chapter menus. Press **▶** (PLAY), the screen shows the menu. Press **▶▶|** or **|◀◀** to skip the next or previous page, select with number buttons or direction buttons.

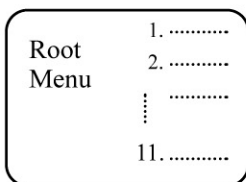

Example: select track 13.

1. Press **▶▶|** to enter the next menu.

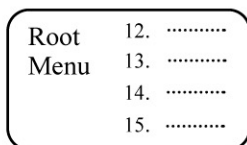

2. Press number buttons to select directly.

FUNCTION SETTING

MENU SETTING



According to the recorded information and external equipment, set the following functions for the player to obtain the best playing status.

1. Press **SETUP** to set the main menu.



The main menu appears on the screen, with icons across the top of the screen, illustrating General Setup, Audio Setup, Preference, Password Setup, and Exit.

The screen shows:

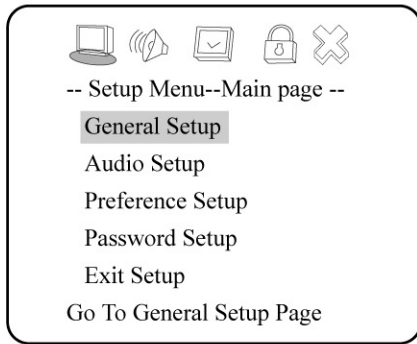

2. Press direction buttons (▼ or ▲) to select and press ► (PLAY) to confirm.

Example: Select "Audio Setup" and do some setup.

◦ Press direction button ▼ to highlight "Audio Setup", press ► (PLAY) to enter "Audio Setup Page".

The screen shows:

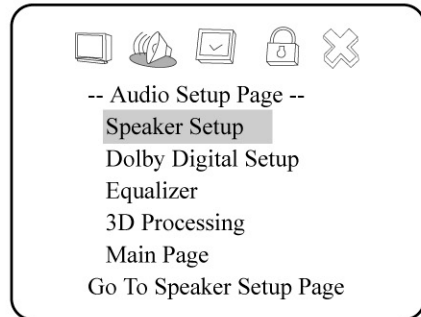

◦ Press direction buttons (▼ or ▲) to highlight "Dolby Digital Setup", and press ► (PLAY) to enter "Dolby Digital Setup" Page. The screen shows the submenu for your selection.

The screen shows:

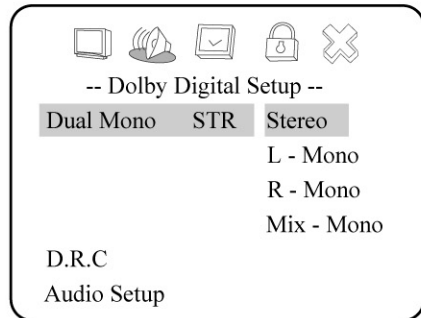

◦ Press direction buttons ►, ▼ to select "L - Mono".

The screen shows:

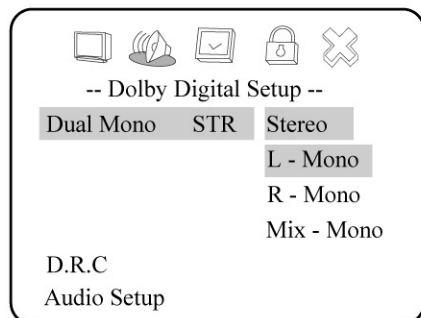

FUNCTION SETTING

- Press ► (PLAY) to confirm your selection. Set "Dual Mono" in "Dolby Digital Setup" to "L - Mono".

The screen shows:

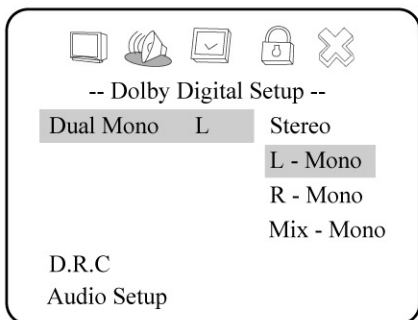

3. Exit setup menu.

- Press the direction button ◀ to exit from "Dual Mono".
- Press the direction button ◀ to exit from "Dolby Digital Setup".
- Press the direction button ▼ to highlight "Main Page" and press ► (PLAY). The screen shows:

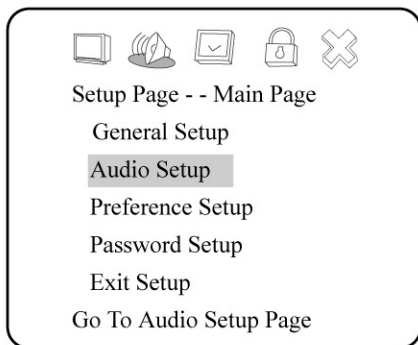

- Press the direction button ▼ to highlight "Exit Setup" and press ► (PLAY) to exit setup menu completely.

NOTE: You can also keep pressing the direction button ◀ until the cursor is moved to the last icon illustrating Exit, then press the ► (PLAY) button to exit setup menu completely.

GENERAL SETUP

The setting structure is as follows:

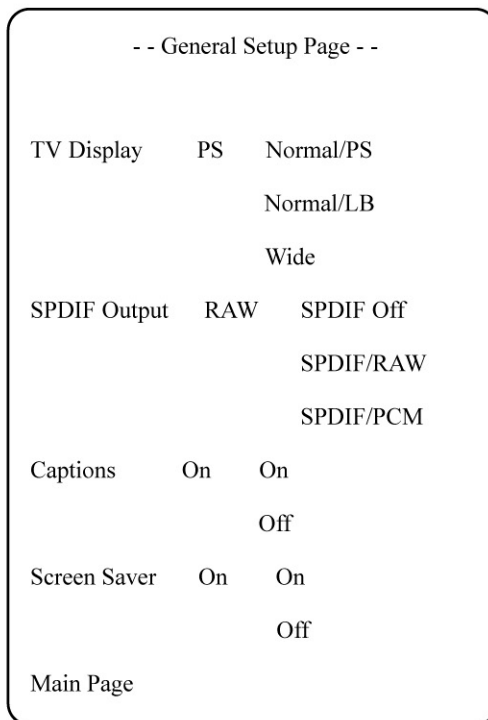

◦^ TV DISPLAY

1. NORMAL/PS

This is selected when the unit is connected to a normal TV.

Wide-screen images are shown on the screen, but with some parts cut automatically.



FUNCTION SETTING

2. NORMAL/LB

This is selected when the unit is connected to a normal TV. Wide-screen images are shown on the screen, with black belt on the top and bottom.



3. WIDE

This is selected when the unit is connected to a wide-screen TV.

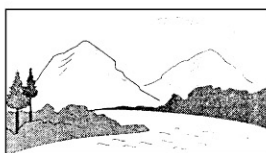

◦^ SPDIF OUTPUT

◦ SPDIF OFF: No signal is output from the digital port.

◦ SPDIF/RAW: Select this when the DVD player is connected with a digital amplifier through digital port. When a Dolby Digital disc or MPEG disc are played, the digital output will be optional. The power amplifier to be connected must have Dolby Digital and MPEG decoding.

◦ SPDIF/PCM: Select this when the DVD player is connected with a 2-channel digital stereo amplifier. When a Dolby Digital or MPEG disc is played, the digital port will output in PCM 2-channel format.

◦^ CAPTIONS

◦ ON

The hidden subtitle is shown.

◦ OFF

The hidden subtitle is turned off.

◦^ SCREEN SAVER

Start the screen saver, the screen saver image appears when the unit stops or the image is frozen for a few minutes. This saver can keep the screen from being damaged.

◦ ON: Start the screen saver.

◦ OFF: Remove the screen saver.

AUDIO SETUP

The setting structure is:

-- Audio Setup Page --

Speaker Setup

Dolby Digital Setup

Equalizer

3D Processing

Main Page

FUNCTION SETTING

◦^ SPEAKER SETUP

The setting structure is:

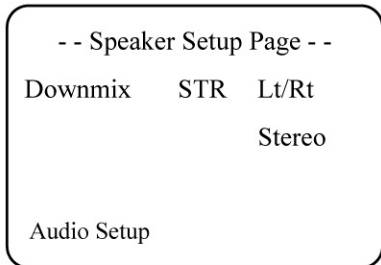

◦ LT/RT

A disc recorded multi channel soundtrack, the output signal will be incorporated to left and right channel.

◦ STEREO

A disc recorded multi channel soundtrack, the output signal will be incorporated to stereo.

◦^ DOLBY DIGITAL SETUP

The setting structure is:

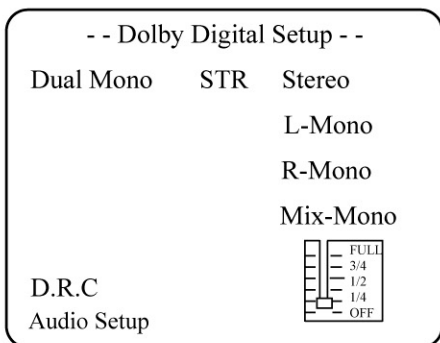

◦ DUAL MONO

This is the output mode of the L and R signals of the set audio output. If it is set to "MIXED MONO", the function only works when the DVD being played is 5.1-channel.

◦ D.R.C

This is selected to adjust linear compression rate to obtain the different compression results of the signals.

◦^ EQUALIZER

This will help you to select graphic equalizer patterns according to the genre of the music being played, and adjust the equalizer.

The setting structure is:

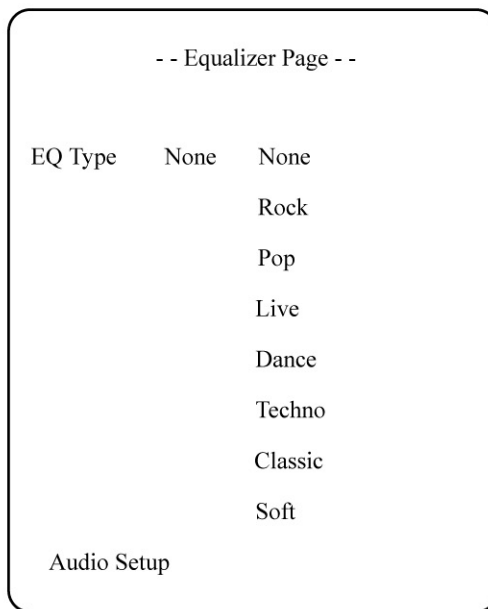

◦ EQ TYPE

You can select music category by pressing the direction buttons and confirm by pressing the **PLAY** button.

FUNCTION SETTING

◦^ 3D PROCESSING

The setting structure is:

| -- 3D Processing Page -- | | |
|--------------------------|-----|-------------|
| V SURR | Off | On |
| | | Off |
| Reverb Mode | Off | Off |
| | | Concert |
| | | Living Room |
| | | Hall |
| | | Bathroom |
| | | Cave |
| | | Arena |
| | | Church |
| Audio Setup | | |

◦ V SURR

Use to turn Virtual Surround on and off.

◦ REVERB MODE

Use to select a Reverb Mode that you want to use.

PASSWORD SETUP

The setting structure is :

| -- Password Setup Page -- | | |
|---------------------------|-----|--------|
| Password Mode | Off | On |
| | | Off |
| Password | | Change |
| Main Page | | |

◦^ PASSWORD MODE

- ON: The password works, "PARENTAL" is dim and can not be selected.
- OFF: The password is locked, "PARENTAL" can be selected.

◦^ PASSWORD CHANGE

Select this to adapt the code, the screen shows:

| | |
|-----------------------------------|----------------------|
| Old Password | <input type="text"/> |
| New Password | <input type="text"/> |
| Confirm PWD | <input type="text"/> |
| <input type="button" value="OK"/> | |

Enter a password according to the screen.

Note: The password is automatically factory set to 99999.

FUNCTION SETTING

PREFERENCES

The setting structure is :

| | | |
|-----------------------|-------|--|
| -- Preference Page -- | | |
| Audio | ENG | English French Spanish Chinese Japanese |
| Subtitle | ENG | English French Spanish Chinese Japanese Off |
| Disc Menu | ENG | English French Spanish Chinese Japanese |
| Country Region | USA | China France Hong Kong Japan Taiwan GBR USA |
| Parental | 08 | 1 KID SAF 2 G 3 PG 4 PG 13 5 PGR 6 R 7 NC17 8 ADULT |
| Default | Reset | |
| Main Page | | |

°^ LANGUAGE SELECTION

If a language mentioned above is recorded on the disc, you can select sounds, subtitles or disc menu languages. If not, the language recorded on the disc is shown.

°^ PARENTAL LOCK

When playing disc with parental lock function, you may select an age control grade according to grade of disc and your desire.

Example: Select "PG" , you cannot play DVD video disc rated higher than the PG grade.

°^ DEFAULT >> RESET

Each function setting returns to the initial status in the factory if you select this option.

Note:

° "PREFERENCES" only can be selected after the unit goes into stop mode.

PLAY DISCS IN VARIOUS WAYS

AUDIO MODE



- You may select a needed language from a multi-language DVD .
- You may select the right channel or left channel or stereo from a multi-channel CD.

WHEN PLAYING DVD

- Press [LANGUAGE], the screen shows orderly:

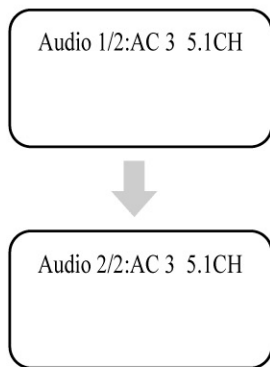

Different discs differ in languages.

- Press [AUDIO MODE], the screen shows orderly:

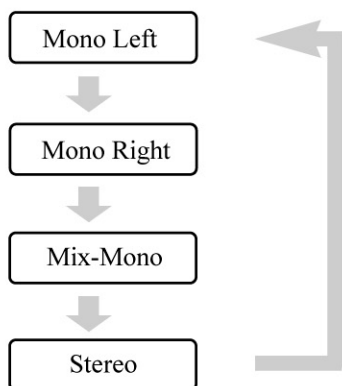

WHEN PLAYING CD

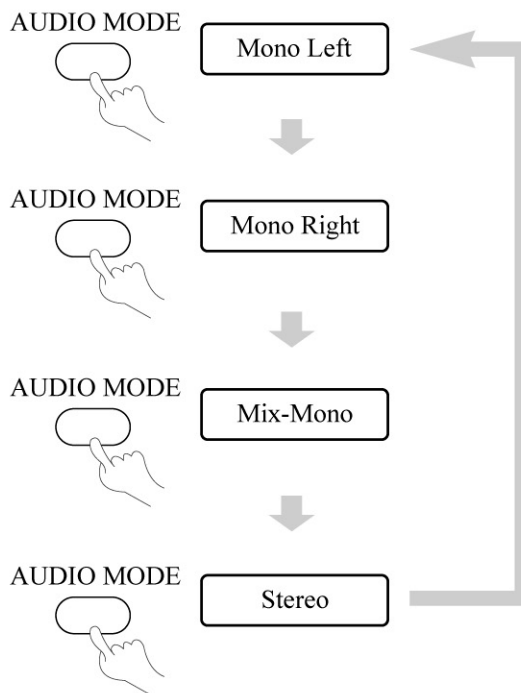

You may select one mode.

Notes:

- Different discs differ in languages.

PLAY DISCS IN VARIOUS WAYS

FAST PLAY



When playing a disc, you may play it forward fast or reverse it fast to find what you want.

WHEN PLAYING DVD OR CD

1. Press **▶▶** to play forward fast. Each time you press the button, the screen shows orderly:

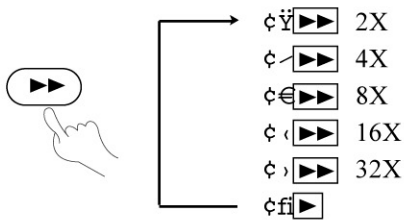

2. Press **◀◀** to reverse the disc fast. Each time you press the button, the screen shows orderly:

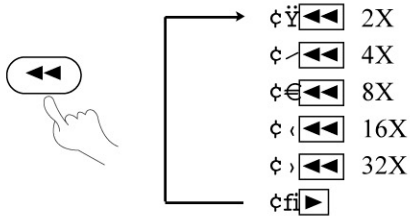

3. Press **▶** (PLAY) to switch to normal play while FF or FR playing.

SLOW PLAY



Enjoy slow motions by the following steps.

WHEN PLAYING DVD

1. Press SLOW to play slowly.

SLOW



The screen shows orderly:

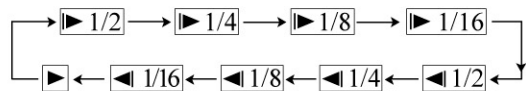

2. Press **▶** (PLAY) to play normally.

PLAY DISCS IN VARIOUS WAYS

REPEAT PLAY



This function can be used to repeatedly play a title, chapter, track, disc, or some part on a disc.

PLAYING A DISC REPEATEDLY

°^ DVD

You may repeat a title or chapter.

1. Repeat a chapter.

Press **REPEAT**, the screen will show



2. Repeat a title

Press **REPEAT** twice, the screen will show

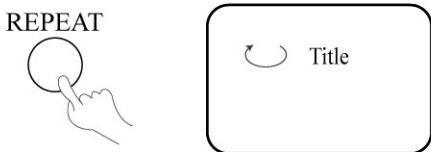

3. Repeat all.

Press **REPEAT** third time, the screen shows "⌚ ALL".

4. Remove "REPEAT" function.

Press **REPEAT** until "⌚ ALL" disappears.

°^ CD

° You may repeat a track, a disc according to the following steps.

1. Repeat a track.

Press **REPEAT**, the screen shows "⌚ Track". The unit plays the current track.

REPEAT

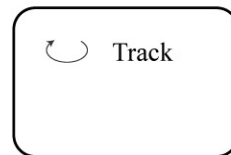

2. Repeat a disc.

Press **REPEAT**, the screen shows "⌚ ALL". The unit plays all the tracks on the disc.

REPEAT

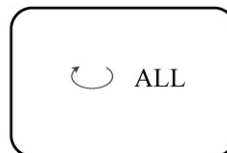

3. Remove "REPEAT" function.

Press **REPEAT** till "⌚ ALL" disappears.

REPEAT SOME PARTS

You may press **A-B** to enjoy some parts repeatedly when playing a disc.

°^ PLAY DVD or CD.

1. Set a starting point A.

The screen shows:



2. Set an end point B.

The screen shows:



Afterwards, the unit plays from A to B.

3. Press **A-B** again till "⌚ AB" disappears.

PLAY DISCS IN VARIOUS WAYS

SELECT SUBTITLES

This operation works only with discs on which multiple subtitle language are recorded.

PLAY DVD

1. Press **SUBTITLE** repeatedly until the desired language is selected.

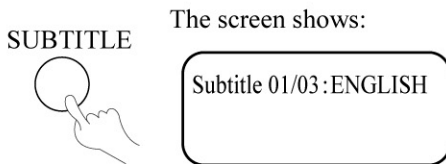

2. Remove the subtitle.
Press **SUBTITLE** until the screen shows "Subtitle Off".

Notes:

- ° For some discs, subtitles can not be removed.
- ° Different discs differ in the language of subtitles.
- ° If the subtitles of discs can not be selected, press **SUBTITLE**, the screen shows "  ".

ANGLES SELECT

Some discs have images with different viewing angles, you may select among them. For example, when you watch a running train, you may watch it from the front, the left window or the right window without stopping it.

Example:

A DVD has four viewing angles at your option.

1. Press  to select ANGLE1.

SCREEN

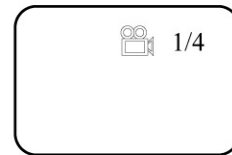

2. Press  to select other angles, the screen shows respectively:

 2/4 (select ANGLE2)

 3/4 (select ANGLE3)

 4/4 (select ANGLE4)

3. To resume normal playback, press  to select original angle.

PLAY DISCS IN VARIOUS WAYS

TIME SEARCH

TIME SEARCH

You may directly enter a time, title or chapter number to search fast on a disc, the unit plays from that point.

◦^ PLAY DVD

1. Search a title or a chapter.

Example: Search chapter 2 in title 6.

- Press **TIME SEARCH**, the screen shows:

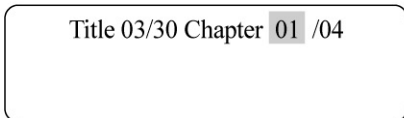

Title 03/30 Chapter 01 /04

- Press the direction button and move the cursor to illuminate the title number.

The screen shows:

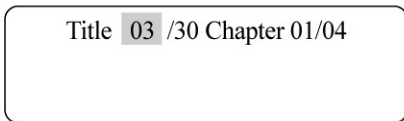

Title 03 /30 Chapter 01/04

- Press button **6** to select title 6, the screen shows:

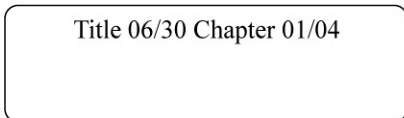

Title 06/30 Chapter 01/04

- Repeat the steps above, select chapter 2 in title 6.

2. TIME SEARCH

- Press **TIME SEARCH** until the screen shows:

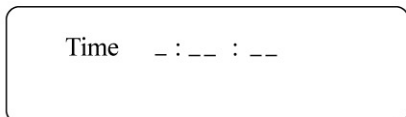

Time _ : _ : _

- Press number buttons to enter hour, minute and second.

Example: Enter **1,0,2,3,8**

After setting, the unit will play the disc from 1:02:38.

◦^ PLAY CD

To jump to a specific time, use **TIME SEARCH** to set the time for the desired location.

Example: Play from 00:01:38 of track 6.

1. Press button **6** to select track 6.

The screen shows:

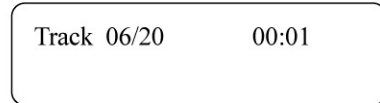

Track 06/20 00:01

2. Press **TIME SEARCH** until the screen shows:

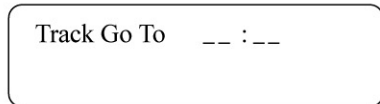

Track Go To _ : _

3. Press button **0,1,3,8** to enter the time.

The screen shows:

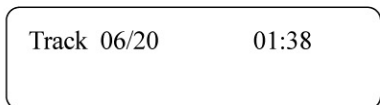

Track 06/20 01:38

- The unit plays from 00:01:38 of track 6 after setting.

- Press **10/0** to enter 0.

Note: CD discs have three options in time search function:

- You can enter the elapsed time of a disc to play.
- You can enter the elapsed time of a track to play.
- You can go to a track you want play by entering the track number.

PLAY DISCS IN VARIOUS WAYS

BOOKMARK



The bookmark feature lets you mark a point on the disc that you can go to quickly. You can store up to 12 bookmarks per disc. When you turn the player off or remove the disc, bookmarks are cleared.

Storing a Bookmark

1. While a disc is playing, press **RESUME** on the remote.
2. The Bookmark Menu appears.
3. When you reach the scene you want to mark, press **PLAY**.
4. If you want to mark another point, press **▶** the button to move the cursor to next spot. When you reach another scene you want to mark, press **PLAY**.
5. Press **RESUME** to make the Bookmark Menu disappear from the screen and resume to normal playback.

Using a Bookmark

1. While a disc is playing, press **RESUME** on the remote.
2. The Bookmark Menu appears.
3. Use the direction buttons to highlight the bookmarked scene you want to activate. Press **PLAY** to go to the place you marked.

ZOOM PLAY



This function can be used to watch a motion or motionless picture.

1. Press **ZOOM** during playback, the screen shows:

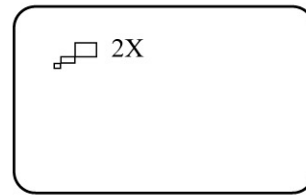

The picture is enlarged twice the size.

2. Press **ZOOM** again, the screen shows:

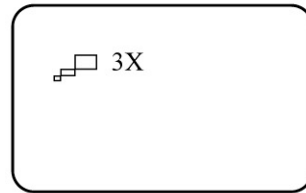

The picture is enlarged three times the size.

Note: The unit has six zoom steps:

2X, 3X, 4X, 1/2, 1/3, and 1/4.

3. Push **◀**, **▲**, **▼**, **▶** to move the enlarged picture.
4. To resume the picture, push **ZOOM** until the picture is in normal size.

PLAY DISCS IN VARIOUS WAYS

PROGRAM PLAY

To use the program playback feature, you must enter the order in which you want the titles (and chapters) on the DVD or the tracks on the CD to play by creating a program.

WHEN PLAYING DVD

1. Press **PLAY MODE** until the screen shows:

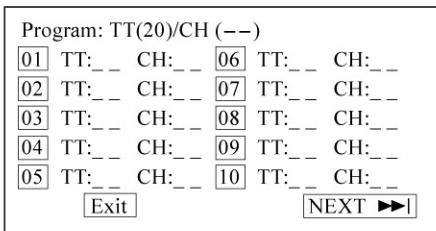

2. Use the number buttons on the remote to enter the title (and chapter) you want to play first. The title (and chapter) number you entered appears in the box. The screen shows:

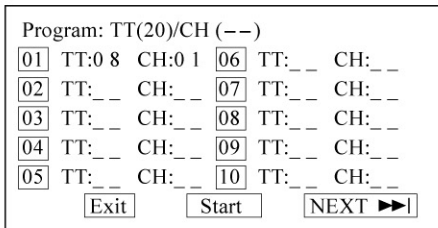

3. The cursor jumps to the next spot in the program list section.

Make sure the box is highlighted and enter your next track.

4. Continue adding titles (and chapters) until your program is complete. You can play your program by highlighting **START** and press **PLAY**.

Note: If the titles (and chapters) you want

to program are more than 10, you can highlight **NEXT** and press **PLAY** to go to the next page.

5. To remove program playback, press the **STOP** button twice during the program play.

WHEN PLAYING CD

1. Press **PLAY MODE** until the screen shows:

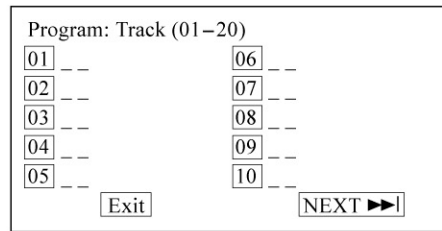

2. Use the number buttons on the remote to enter the track number you entered appears in the box. The screen shows:

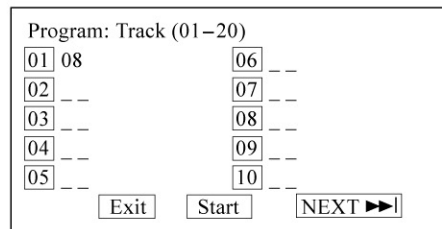

3. The cursor jumps to the next spot in the program list section. Make sure the box is highlighted and enter your next track.

4. Continue adding tracks until your program is complete. You can play you program by highlighting **START** and press **PLAY**.

Note: If the tracks you want to program are more than 10, you can highlight **NEXT** and press **PLAY** to go to the next page.

5. To remove program playback, press the **STOP** button during the program play.

PLAY DISCS IN VARIOUS WAYS

SHUFFLE OR RANDOM PLAY



The unit can play by random orders.
The order is different each time.

1. Press **PLAY MODE** to select shuffle or random play mode while a disc is playing.

PLAY MODE



The screen shows:

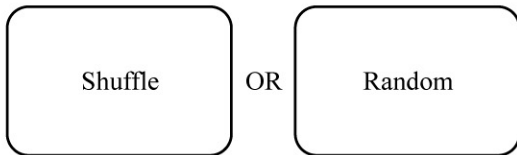

2. press **▶ (PLAY)** to start shuffle or random play.
The unit selects a track to play.
3. Remove shuffle or random play.
 - When playing a DVD disc, press **◦^** twice.
 - When playing a CD disc, press **◦^**.

DIGEST PLAY



This function can be used to look through the content of the track or disc.

PLAYING DVD

1. Press **DIGEST** while a disc is playing.

DIGEST



The screen shows:

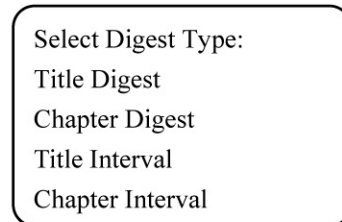

Use the **▼** or **▲** buttons to select "TITLE DIGEST" and press **PLAY** to confirm.

The unit begins to look through the titles, and shows the starting picture of each title on the screen.

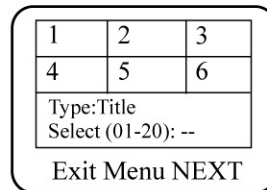

Each page has six pictures, their location may be different.

2. Use the direction buttons to select **NEXT** on the screen, and press **PLAY** to go to the next page.

PLAY DISCS IN VARIOUS WAYS

- To remove the digest feature, use the direction buttons to select EXIT on the screen and press **PLAY** to confirm.

Note: If you have stored bookmarks on a DVD disc, there will be one more digest option: BOOKMARK DIGEST.

PLAYING CD

- Press **DIGEST** after the unit stops.



The screen shows:

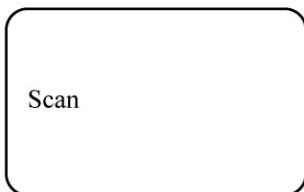

The unit plays the first ten seconds of each track one after another.

- Remove digest play.
Press **STOP**, digest play is removed and the unit stops.

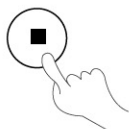

Note: A CD disc only has "SCAN" function.

MP3 OPERATION

SELECT TRACKS WITH MENU

- Insert a disc, the unit will search disc information. The TV screen displays main menu.

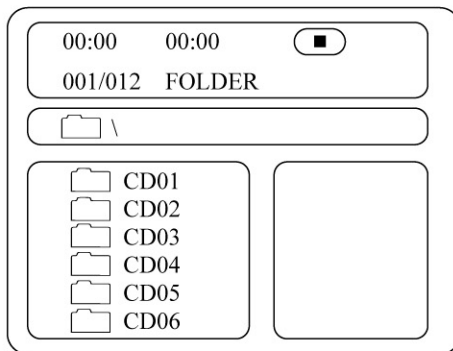

- Press direction key **▼** to select song folder. Press **▶** (PLAY) to confirm selection. Example: Select CD02, the TV screen displays.

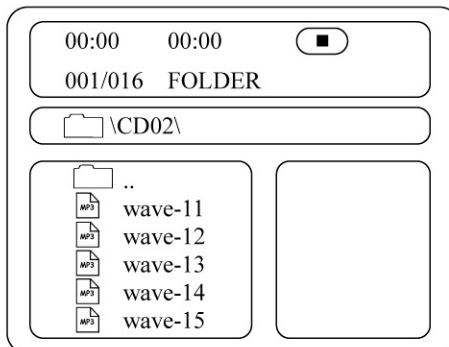

- Press direction buttons to select a song.
Press **▶** (PLAY) button to start playback.
- Press **▲** or **▼** button to select other tracks, and press **▶** (PLAY) button to play.
- In stop mode, select the folder icon on the left side, then press **▶** (PLAY) button to return to the main menu.
- Press **▶|◀** or **▶|◀|◀** to play previous or next songs.

OTHER FUNCTIONS

During playback MP3 discs, the unit features mute, volume control, repeat play and etc. Operations are the same as CD.

OTHERS

ACCESSORIES

Check if you have all the accessories after the carton is opened.

- Audio cable 1
- Video cable 1
- Remote control 1
- Owner's manual 1
- AC power adaptor 1
- Rechargeable battery pack 1
- Warranty card 1
- Car cigarette adaptor 1

PRECAUTIONS FOR DISC

HANDLING DISC

- To keep the disc clean, do not touch the play sides of the disc
- Do not attach paper or tape to the disc.



- Keep the disc away from direct sunlight or heat sources.
- Store the disc in a disc case after playback.

CLEANING DISC

- Before playback, wipe the disc outwards from the center with clean cloth.



TROUBLE SHOOTING

If you experience the following problems while using the unit, this troubleshooting guide can help you.

No sound

- Check if the unit is connected securely.
- Check if the volume of headphone is set to MIN when using headphone.
- Make sure you operate the TV or amplifier correctly.
- Make sure you have selected DVD player position on the amplifier.

No image

- Check if the unit is connected securely.
- Make sure you operate the TV correctly.
- Make sure you set the color system correctly.

Bad sound quality

- Make sure the audio output mode is set correctly.
- Make sure the audio connection between the unit and amplifier is right.

Disc can not be played

- There is no disc in the unit.
- Put the disc on the disc tray properly with the label side up.
- Clean the disc.
- Moisture has condensed in the unit.
Remove the disc and leave the unit on for about one hour.

Remote control does not work

- Remove barriers between the remote control and the unit.
- Point the remote control at the remote control sensor of the unit.
- Replace the batteries with new ones.

Image rolls and no color

The color system of the unit doesn't match with that of TV. Please select the correct TV TYPE until TV shows normal color.

OTHERS

TECHNICAL SPECIFICATIONS

| | | |
|------------------------------|-------------------------------------|---|
| Laser | wavelength 650nm | |
| Video system | NTSC | |
| Frequency response | 20Hz \sim 20KHz \pm 1dB | |
| Signal/noise ratio | \geq 95dB | |
| Audio distortion + noise | \leq -80(1KHz) | |
| Channel separation | \geq 85dB | |
| Dynamic range | \geq 85dB | |
| Output | Audio out (analog audio) | Output level: 2V \pm 10% Load impedance: 10k Ω |
| | Audio out (digital audio) | Output level: 0.5Vp - p |
| | Video out | Output level: 1Vp - p \pm 20% Load impedance: 75 Ω , imbalance, negative polarity |
| Power supply | DC 9V 2A | |
| Allowable motion temperature | 5 $^{\circ}$ \sim 35 $^{\circ}$ C | |
| Power Consumption | \leq 20W | |
| Dimensions | 210 \times 150 \times 30mm | |
| Weight | 830g | |

This manual is only for your reference, any change to the design and specifications will not be advised.

This product incorporates copyright protection technology that is protected by method claims of certain U.S. patents and other intellectual property rights owned by Macrovision Corporation and other rights owners. Use of this copyright protection technology must be authorized by Macrovision Corporation, and is intended for home and other limited viewing uses only unless otherwise authorized by Macrovision Corporation. Reverse engineering or disassembly is prohibited.

USING THE BATTERY PACK

Attach the battery pack properly following the explanation below. Make sure that the battery pack is attached firmly to the player when using it. Otherwise, the battery may become detached and cause person injury. Charge it before using.

■ ATTACHING THE BATTERY PACK

First disconnect the AC adaptor and the power cord from the player, then attach the battery pack.

1. Turn the player off.
2. Turn the player upside down.
3. Insert the battery pack's catches into the player's corresponding holes.

Then, slide the battery pack until it is attached firmly.

Note: Remove the battery pack from the player after being used.

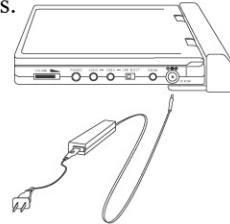

■ CHARGING THE BATTERY PACK

1. Turn the player off. The battery pack will charge only when the POWER to the player is turned OFF.
2. Attach the battery pack to the player.
3. Connect the supplied AC adaptor and the power cord to the player.
Charging starts, and the POWER/CHG indicator illuminates orange. When the charging is completed, the indicator turns off.

Notes:

- 1) While the charge is in progress, do not disconnect the AC adaptor and the power cord until the POWER/CHG indicator turns off. The charging time of a battery pack is approximately 5 hours and depends on environmental conditions.
- 2) The attached battery pack may get warm when you are charging it or operating the player. This is not a defect.
- 3) The battery indicator is shown on the screen when the power in the battery pack is running low.



■ DETACHING THE BATTERY PACK

1. Turn the player off.
2. Disconnect the AC adaptor and the power cord from the player.
3. Turn the player upside down.
4. Slide the battery pack's lock switch in the open direction, then slide the player in the correct direction to remove it.

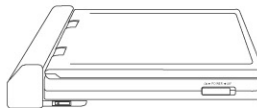

■ PLAYBACK TIME

Generally, after the battery pack is recharged, its continuously working time is as follows.

For example:

| Model | Operating status | Continuous playing time |
|---------|-------------------|-------------------------|
| MM-8000 | Play DVD, TFT on | about 4 hours |
| | Play DVD, TFT off | about 6 hours |

■ CONDITIONS AND ATTENTION

While using the battery pack, the environmental temperature should be 5°C (41°F) to 35°C (95°F).

A newly purchased battery pack can only be used after being charged.

To undertake the longest service life of the battery pack, charge it under or close to indoor-temperature.

Never dispose of in fire, water or heat up.

Do not use in high temperature or near heat sources.

Never connect the positive and negative poles with metal.

Do not open the battery, refer servicing only to qualified service personnel.